

Aufbauanleitung Partyzelt Premium 6x6 m, 6x8 m, 6x10 m, 6x12 m

Assembly instructions for Event Tent Premium 6x6 m, 6x8 m, 6x10 m, 6x12 m

Herzlichen Glückwunsch zum Kauf Ihres neuen Zeltes. Bei Fragen oder Anregungen wenden Sie sich gerne an unser Kundenservice-Team. Beachten Sie bitte die nachfolgenden Hinweise, damit Sie lange Freude an Ihrem Zelt haben.

Congratulations on the purchase of your new tent. If you have any questions or suggestions, please contact our customer service team. Please note the following information, so you can enjoy your tent for a long time to come.

HINWEISE | NOTE

Das Zelt ist nicht auf Wind- und Schneelasten getestet worden. Somit kann hierfür keine Garantie übernommen werden. Beachten Sie den Wetterbericht, um im Bedarfsfall das Zelt rechtzeitig zu sichern und/oder abzubauen.

The tent has not been tested for wind or snow loads. Therefore, no guarantee can be given for service life and/or performance. Pay attention to the weather forecast in order to secure and/or disassemble the tent if necessary.

1. Zelte sind als temporäre Unterkunft gedacht und sollten bei widrigen Witterungsverhältnissen abgebaut werden.

Tents are intended as temporary accommodation and should be dismantled in adverse weather conditions.

2. Bitte achten Sie darauf, das Zelt vorsichtig zu behandeln, um Defekte zu vermeiden.

Please handle the tent with care to avoid defects.

3. Das Gestänge nicht zu kräftig behandeln, um Beschädigungen zu vermeiden.

Do not handle the struts too forcefully in order to avoid any damages.

4. Bitte wählen Sie immer einen geeigneten Abstand zu Schläuchen, Gas- oder Elektroleitungen, um diese nicht zu beschädigen.

Please always choose a suitable distance from hoses, gas or electric lines in order not to damage them.

5. Beim Einsatz geeigneter Heizgeräte (Auskunft im Fachhandel) ist ein Abstand von mindestens 1,2 m zu jeglichem Planenmaterial zu beachten. Offenes Feuer sowie Heizgeräte mit offenen Flammen wie Heizpilze, Terrassenstrahler, Gasheizer etc. sollten auf keinen Fall verwendet werden.

When using suitable heaters (information in specialty shops) a distance of at least 1.2 m to any tarpaulin material must be observed. Open fire and heating devices with open flame sources such as patio heaters, gas heaters, etc. should never be used.

HINWEISE | NOTE

6. Der Aufbauer ist verantwortlich für die angemessene Verankerung und damit für die Sicherheit des Zeltens. Die Verankerung muss regelmäßig geprüft werden, um stets die Sicherheit des Zeltens zu gewährleisten und Schäden zu vermeiden.

The assembler is responsible for adequate anchoring and therefore for safety of the tent.
The anchoring must be checked regularly to always ensure security of the tent and to avoid any damage.

7. Tragen Sie beim Aufbau des Zeltens ggf. passende Schutzkleidung wie Handschuhe, stabile Schuhe und einen Helm.

If necessary, wear suitable protective clothing such as gloves, sturdy shoes and a helmet when setting up the tent.

8. Achten Sie darauf, dass der Untergrund für Ihre Nutzungszwecke geeignet ist. Das Zelte sollte auf ebenen Untergrund gestellt werden. Verwenden Sie nur die mitgelieferten Materialien.

Make sure the surface is suitable for your purposes. The tent should be placed on level ground. Use only materials provided.

9. Das Zelt ist auch bei leichteren Minustemperaturen für einen Einsatz geeignet. Die Planen müssen aber bei mindestens 10 °C lange genug gelagert und entfaltet werden. Ansonsten kann es zu Bruchstellen an den gefalteten Stellen kommen.

The tent is also suitable for use in slightly sub-zero temperatures. However, the tarpaulin must be stored and unfolded at a temperature of at least 10 °C, otherwise breakage may occur in the folded points.

REINIGUNG UND WARTUNG | CLEANING AND MAINTENANCE

Dach und Seitenteile lassen sich mit Seifenlauge abwaschen. Schimmel und Stockflecken entfernen Sie mit einer milden Chlorklösung. Befolgen Sie die Anweisungen des Herstellers und testen Sie die Chlorklösung an einer nicht sichtbaren Stelle, um sicherzugehen, dass keine Verfärbungen auftreten.

Achtung! Das Partyzelt muss vor dem Zusammenlegen und Verstauen vollständig getrocknet sein! Bitte niemals nass zusammenlegen.













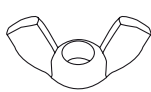

The roof and side walls can be cleaned with soapy water. Mold and mold stains can be removed with a mild chlorine solution. Follow the manufacturer's instructions and test the chlorine solution on a small and less prominent area to make sure there is no discoloration.

Warning! The marquee must be completely dry before folding and storing away. Please never fold the marquee when wet!

TEILELISTE | LIST OF PARTS

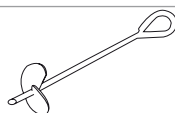
ZIFFER NUMBER	BEZEICHNUNG NAME	TEIL PART	6x6	6x8	6x10	6x12
1	Rohr 1430 mm Pipe 1430 mm		16 Stk./ pcs	20 Stk./ pcs	24 Stk./ pcs	28 Stk./ pcs
2	Rohr 1920 mm Pipe 1920 mm		15 Stk./ pcs	20 Stk./ pcs	25 Stk./ pcs	30 Stk./ pcs
2a	Rohr 1905 mm Pipe 1905 mm		12 Stk./ pcs	14 Stk./ pcs	16 Stk./ pcs	18 Stk./ pcs
3	Standpfosten 1945 mm Leg Pipe 1945 mm		8 Stk./pcs	10 Stk./ pcs	12 Stk./ pcs	14 Stk./ pcs
4	Dachstrebe 1510 mm Connect Pipe 1510		8 Stk./pcs	10 Stk./ pcs	12 Stk./ pcs	14 Stk./ pcs
5	Dachstrebe 560 mm Connect Pipe 560 mm		4 Stk./pcs	5 Stk./pcs	6 Stk./pcs	7 Stk./pcs
6	3-Wege-Eckverbinder 110° ø 54 – ø 41, rechts 110° 3-Way Connector ø 54 – ø 41 (right)		2 Stk./pcs	2 Stk./pcs	2 Stk./pcs	2 Stk./pcs
6a	3-Wege-Eckverbinder 110° ø 54 – ø 41, links 110° 3-Way Connector ø 54 – ø 41 (left)		2 Stk./pcs	2 Stk./pcs	2 Stk./pcs	2 Stk./pcs
7	4-Wege-Eckverbinder 110° ø 54 – ø 41 110° 4-Way Connector ø 54 – ø 41		4 Stk./pcs	6 Stk./pcs	8 Stk./pcs	10 Stk./ pcs
8	3-Wege-Verbinder 140° 140° 3-Way Connector		2 Stk./pcs	2 Stk./pcs	2 Stk./pcs	2 Stk./pcs
9	4-Wege-Verbinder 140° 140° 4-Way Connector		2 Stk./pcs	3 Stk./pcs	4 Stk./pcs	5 Stk./pcs
10	Kreuzverbinder Cross Connector		4 Stk./pcs	6 Stk./pcs	8 Stk./pcs	10 Stk./ pcs
11	T-Verbinder T Connector		4 Stk./pcs	4 Stk./pcs	4 Stk./pcs	4 Stk./pcs
12	Zeltfuß für die Ecken Foot Plate for corner		4 Stk./pcs	4 Stk./pcs	4 Stk./pcs	4 Stk./pcs

TEILELISTE | LIST OF PARTS

ZIFFER NUMBER	BEZEICHNUNG NAME	TEIL PART	6x6	6x8	6x10	6x12
13	Zeltfuß Foot Plate		4 Stk./pcs	6 Stk./pcs	8 Stk./pcs	10 Stk./pcs
14	Zeltfuß für Giebelseite Foot Plate for door side		4 Stk./pcs	4 Stk./pcs	4 Stk./pcs	4 Stk./pcs
16	Flügelmutter M6 M6 Nut		16 Stk./pcs	20 Stk./pcs	24 Stk./pcs	28 Stk./pcs
17	Flügelmutter M8 M8 Nut		102 Stk./pcs	128 Stk./pcs	154 Stk./pcs	180 Stk./pcs
18	Schraube M6 x 30 mm Screw M6 x 30 mm		16 Stk./pcs	20 Stk./pcs	24 Stk./pcs	28 Stk./pcs
19	Schraube M8 x 50 mm Screw M8 x 50 mm		86 Stk./pcs	108 Stk./pcs	130 Stk./pcs	152 Stk./pcs
20	Schraube M8 x 70 mm Screw M8 x 70 mm		16 Stk./pcs	20 Stk./pcs	24 Stk./pcs	28 Stk./pcs
21	Spanngummi kurz Short Bungee		26 Stk./pcs	26 Stk./pcs	26 Stk./pcs	26 Stk./pcs
22	Spanngummi lang Long Bungee		112 Stk./pcs	134 Stk./pcs	156 Stk./pcs	178 Stk./pcs
23	Haken Hook		8 Stk./pcs	10 Stk./pcs	12 Stk./pcs	14 Stk./pcs
24	Schraub-Erdhaken groß ø 6 x 300 mm Peg ø 6 x 300 mm		4 Stk./pcs	4 Stk./pcs	4 Stk./pcs	4 Stk./pcs
25	Erdhaken mittel ø 6 x 180 mm Peg ø 6 x 180 mm		8 Stk./pcs	10 Stk./pcs	12 Stk./pcs	14 Stk./pcs
26	Erdhaken klein ø 4 x 180 mm Peg ø 4 x 180 mm		36 Stk./pcs	42 Stk./pcs	48 Stk./pcs	54 Stk./pcs
27	Abspannseil Rope		4 Stk./pcs	4 Stk./pcs	4 Stk./pcs	4 Stk./pcs

TEILELISTE | LIST OF PARTS

ZIFFER NUMBER	BEZEICHNUNG NAME	TEIL PART	6x6	6x8	6x10	6x12
28	Inbusschlüssel M6 M6 Spanner		1 Stk./pcs	2 Stk./pcs	3 Stk./pcs	4 Stk./pcs
29	Inbusschlüssel M8 M8 Spanner		1 Stk./pcs	2 Stk./pcs	3 Stk./pcs	4 Stk./pcs







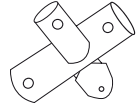
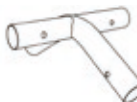

Prüfen Sie die Lieferung anhand der beiliegenden Teileliste auf Vollständigkeit. Achten Sie darauf, dass der Untergrund für den Aufbau Ihres Zeltes geeignet ist. Bei kälterem Wetter empfehlen wir, die Zeltplane vorher auf Zimmertemperatur zu bringen.

Check the delivery for completeness using the enclosed list of parts. Make sure that the ground is suitable for setting up your tent. In colder weather we recommend bringing the tarpaulin to room temperature beforehand.

AUFBAU | ASSEMBLY

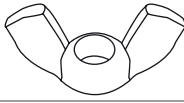
1. Legen Sie Stangen und Verbindungselemente für das Dach gemäß der Abbildung auf dem Boden aus und montieren Sie diese. Zur Fixierung des Daches die Verbinder und Stangen verschrauben. Für die Rohre $\varnothing 38$ mm die 50 mm- Schrauben verwenden, für die Rohre $\varnothing 50$ mm die 70 mm-Schrauben verwenden.

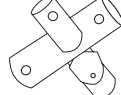
Place poles and roof fasteners on the ground as shown and assemble. To attach the roof, screw together all connectors and rods. Use the 50 mm screws for the $\varnothing 38$ mm tubes and the 70 mm screws for the $\varnothing 50$ mm tubes.



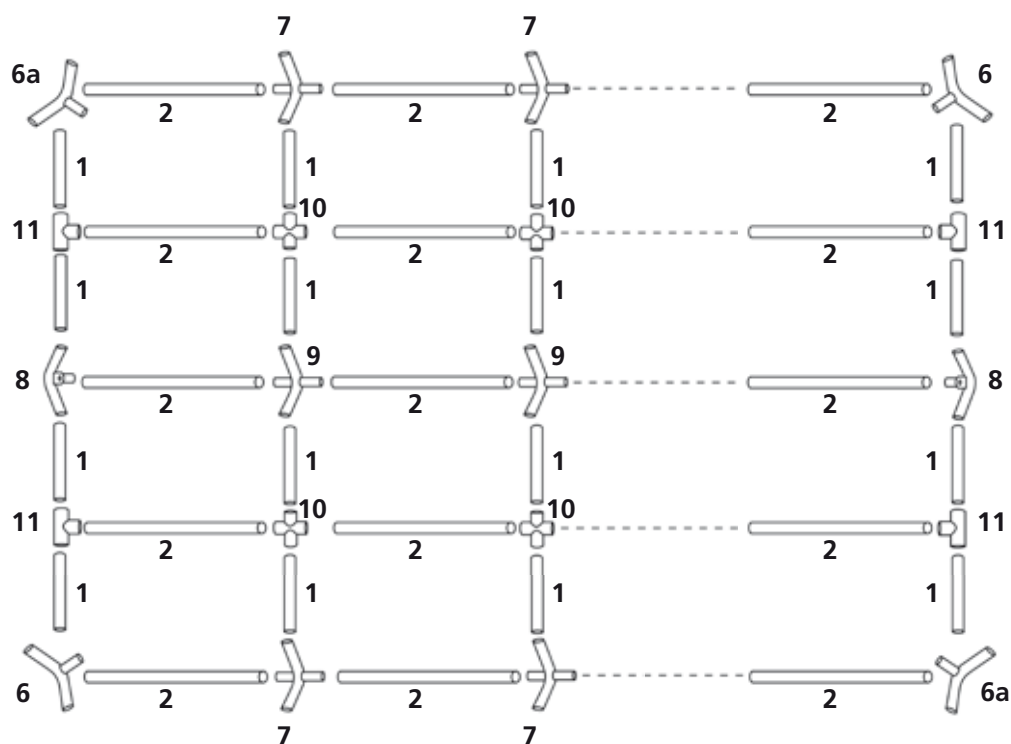

8	3-Wege-Verbinder 140° 140° 3-Way Connector		11	T-Verbinder T Connector	
9	4-Wege-Verbinder 140° 140° 4-Way Connector		1	Rohr 1430 mm Pipe 1430 mm	
6a	3-Wege-Eckverbinder 110° $\varnothing 54 - \varnothing 41$ (links) 110° 3-Way Connector $\varnothing 54 - \varnothing 41$ (left)		2	Rohr 1920 mm Pipe 1920 mm	
6	3-Wege-Eckverbinder 110° $\varnothing 54 - \varnothing 41$ (rechts) 110° 3-Way Connector $\varnothing 54 - \varnothing 41$ (right)		17	Flügelmutter M8 M8 Nut	
7	4-Wege-Eckverbinder 110° $\varnothing 54 - \varnothing 41$ 4-Way Connector $\varnothing 54 - \varnothing 41$		19	Schraube M8 x 50 mm Screw M8 x 50 mm	
10	Kreuzverbinder Cross Connector		20	Schraube M8 x 70 mm Screw M8 x 70 mm	



AUFBAU | ASSEMBLY

2. Befestigen Sie die Dachstreben mit Schrauben und Flügelmutter.

Attach the reinforcement braces with screws and wing nuts.

5	Dachstrebe 560 mm Connect Pipe 560 mm	
4	Dachstrebe 1510 mm Connect Pipe 1510	
16	Flügelmutter M6 M6 Nut	
18	Schraube M6 x 30 mm Screw M6 x 30 mm	

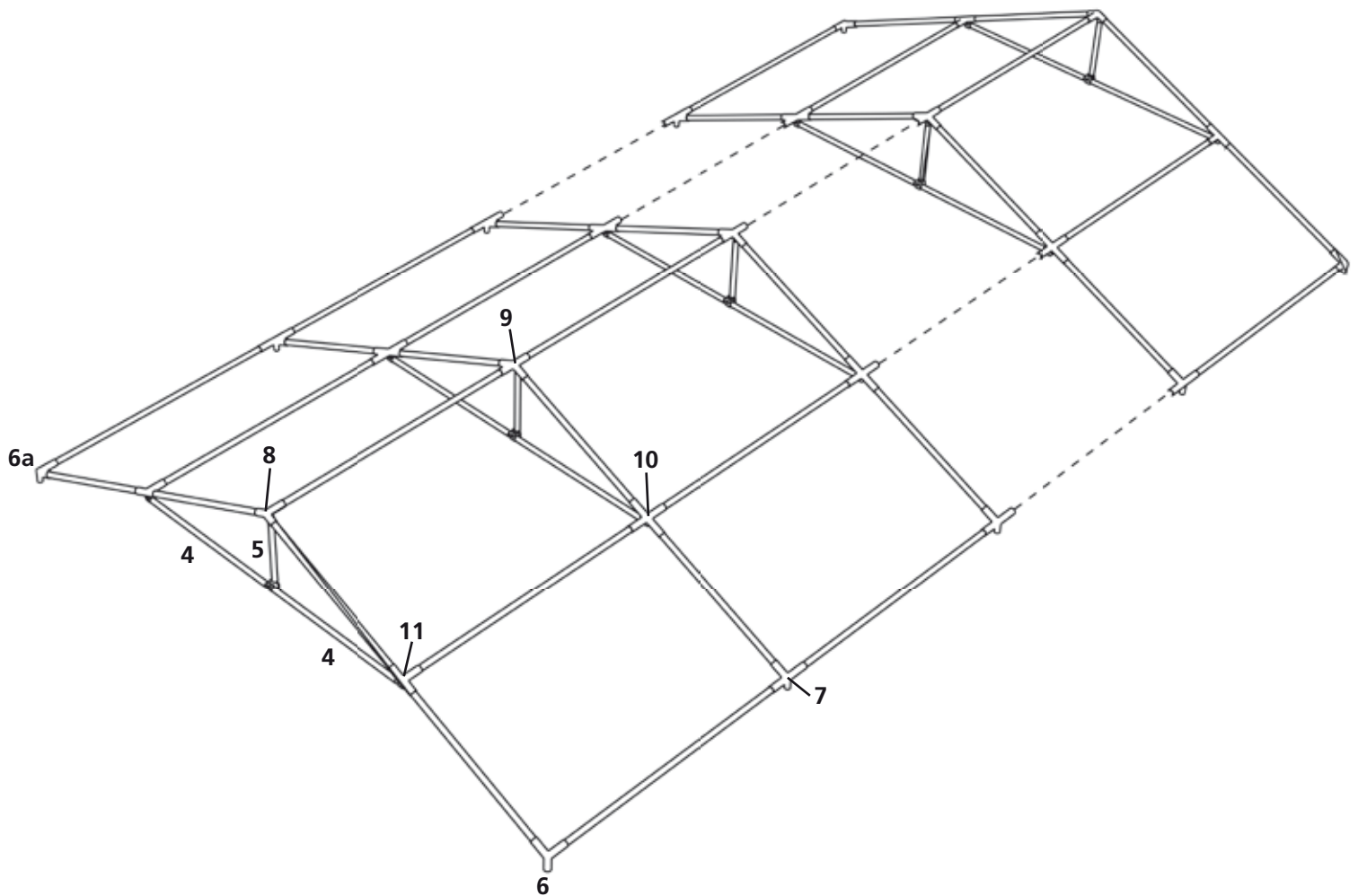

AUFBAU | ASSEMBLY

3. Ziehen Sie die Dachplane über das Gestell und montieren Sie die Standpfosten auf der einen Seite am Dachgestell. Befestigen Sie das Dach mit den Spanngummis am Gestell. Montieren Sie danach die Standpfosten der anderen Seite am Dachgestell.

Pull the roof tarpaulin over the frame and mount the support posts on one side to the roof frame. Fasten the roof to the frame with elastic straps. Mount the support posts on the other side of the roof frame.

22	Spanngummi lang Long Bungee	
3	Standpfosten 1945 mm Leg Pipe 1945 mm	

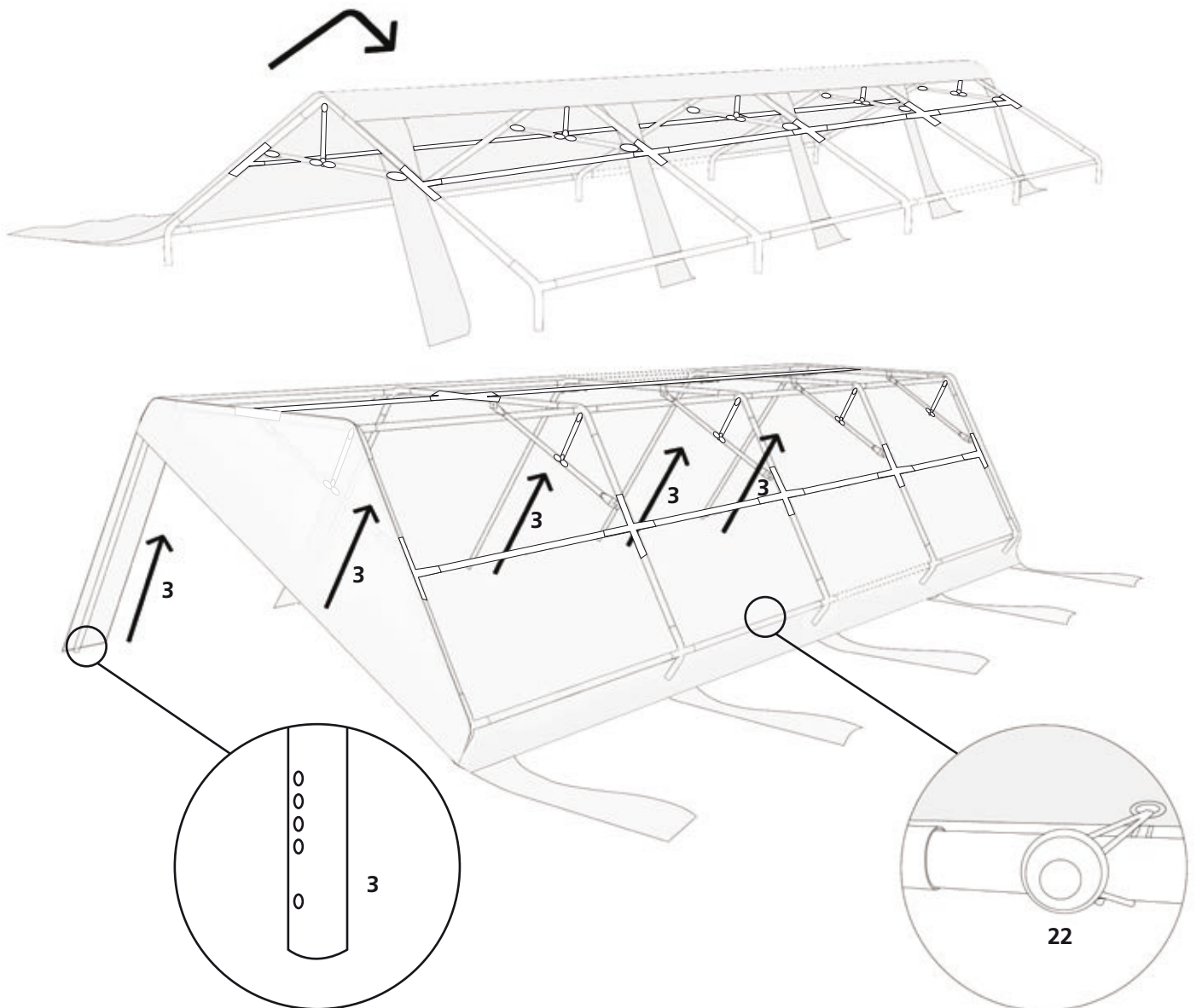

AUFBAU | ASSEMBLY

4. Stecken Sie die Zeltfüße an die Standpfosten. Bitte stellen Sie die Standpfosten senkrecht auf, um zu hohe Spannung auf den Giebelwänden zu vermeiden.

Attach the tent legs to support posts. Set up the posts vertically to avoid excessive stress on the gable walls.



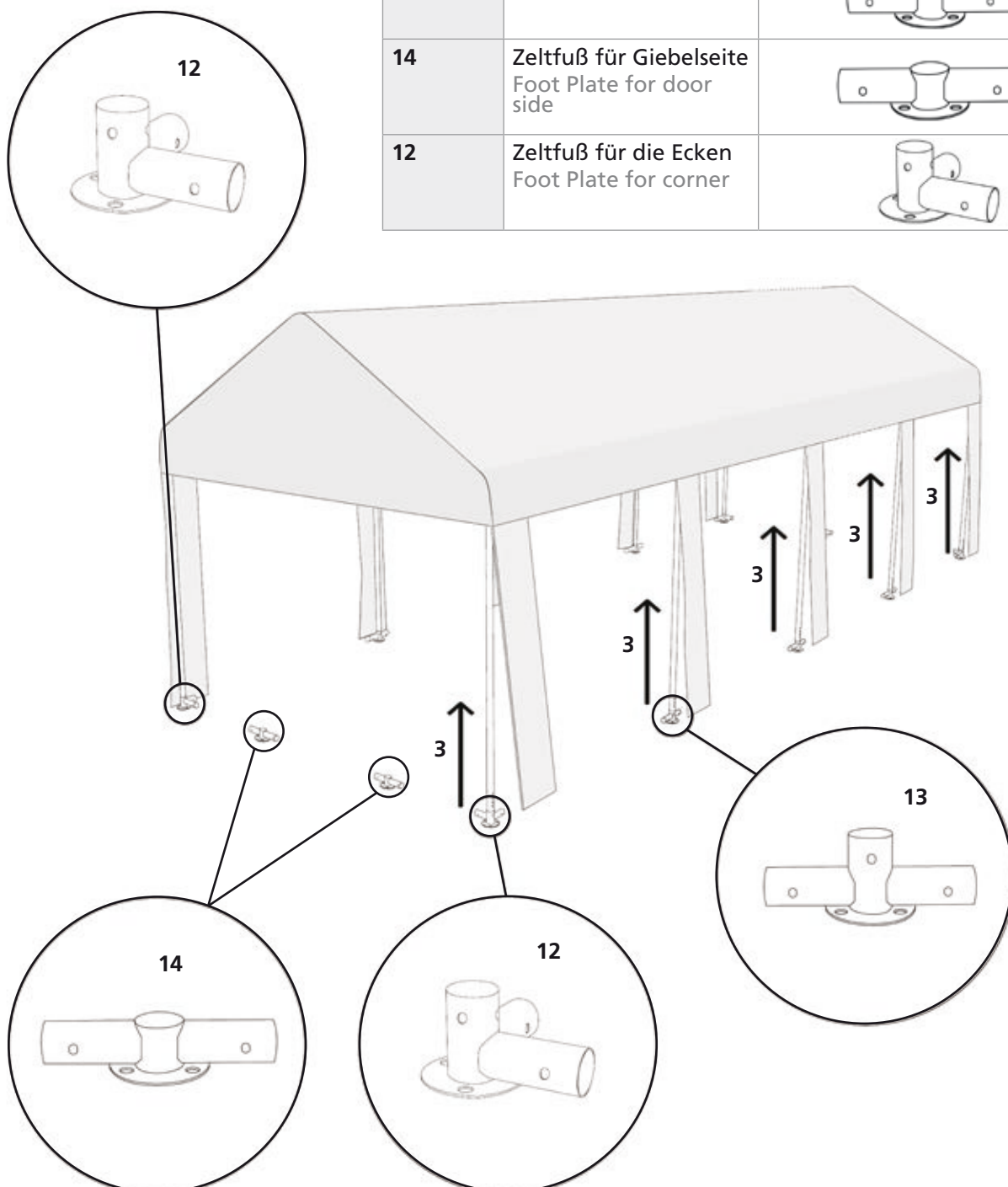

3	Standpfosten 1945 mm Leg Pipe 1945 mm	
13	Zeltfuß Foot Plate	
14	Zeltfuß für Giebelseite Foot Plate for door side	
12	Zeltfuß für die Ecken Foot Plate for corner	

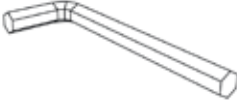

AUFBAU | ASSEMBLY

5. Verschrauben Sie die Zeltfüße und den Bodenrahmen mit den Schrauben und Flügelmutter, sichern Sie anschließend die Zeltfüße mit Erdhaken.

Screw the tent legs and the ground frame together with the screws and wing nuts, then secure the tent legs with ground hooks.

2a	Rohr 1905 mm Pipe 1905 mm	
29	Inbusschlüssel M8 M8 Spanner	
17	Flügelmutter M8 M8 Nut	
20	Schraube M8 x 70 mm Screw M8 x 70 mm	
19	Schraube M8 x 50 mm Screw M8 x 50 mm	
25	Erdhaken mittel ø 6 x 180 mm Peg ø 6 x 180 mm	

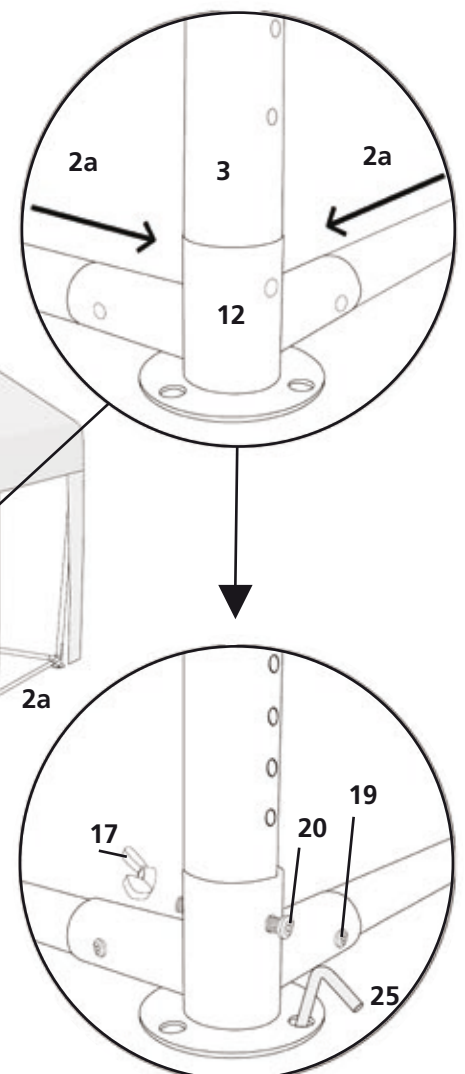
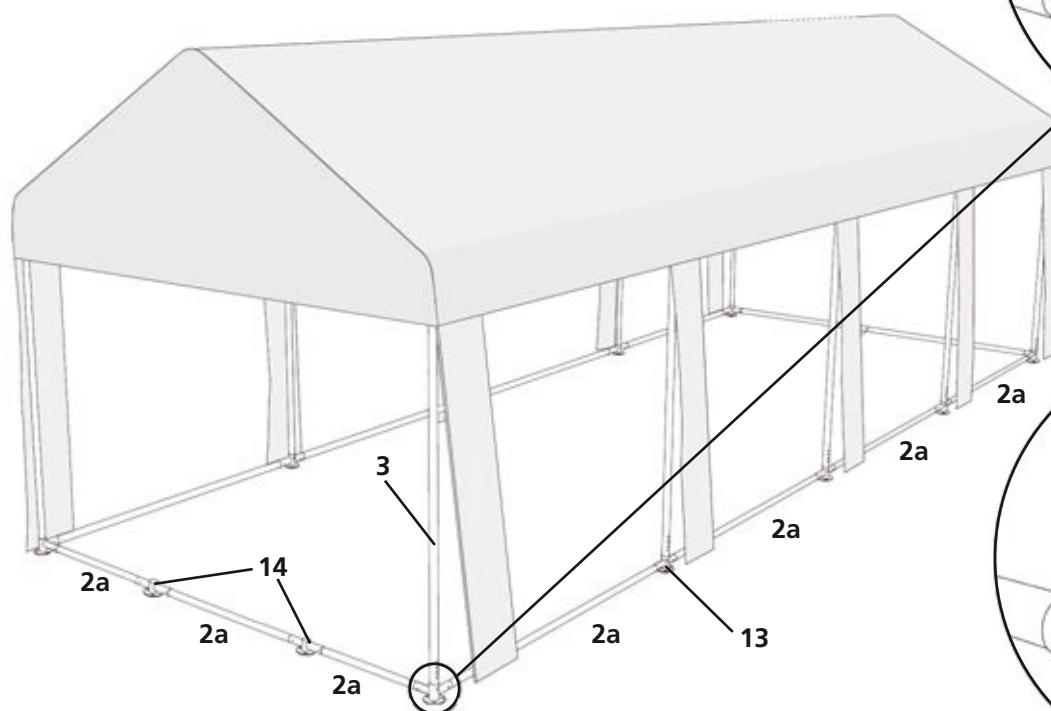

AUFBAU | ASSEMBLY

6. Befestigen Sie die Giebelwände oben mit den Spanngummis an der Dachplane sowie seitlich an den Standpfosten. Sichern Sie die Dachplane mit den Haken am Zeltpfosten.

Fasten the gable walls to the top of the roof tarpaulin with elastic straps and to the side of the poles. Secure the roof tarpaulin to the tent pole with hooks.

21	Spanngummi kurz Short Bungee	
22	Spanngummi lang Long Bungee	
23	Haken Hook	

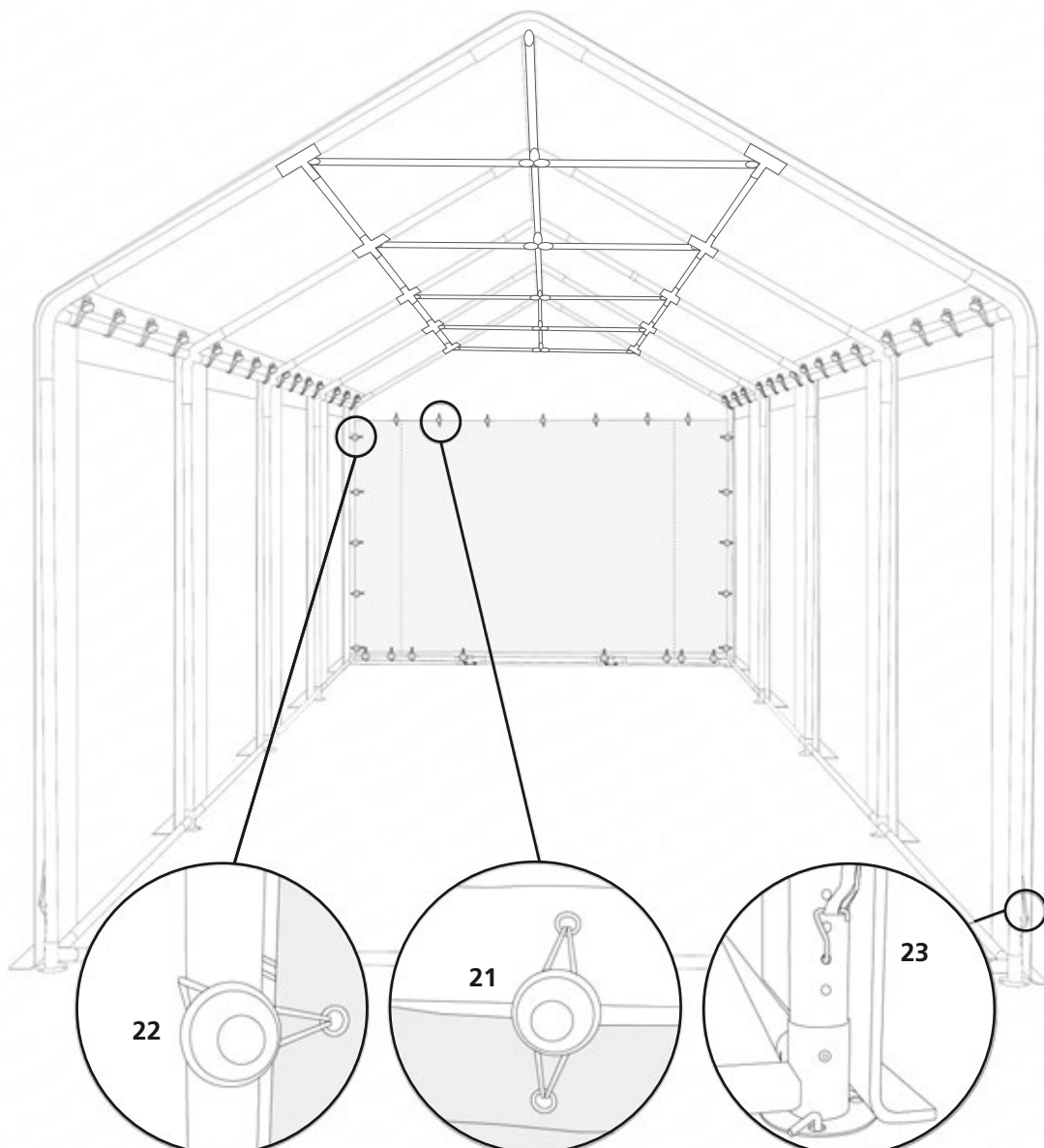

AUFBAU | ASSEMBLY

7. Befestigen Sie die gewünschte Anzahl von Seitenwänden mit den Spanngummis an den Zeltseiten. Befestigen Sie dazu die Seitenwand oben mit den Spanngummis, mit denen bereits das Dach montiert wurde und seitlich mit weiteren Spanngummis.

Attach the desired number of side walls to the tent sides using elastic straps. To do this, fasten the side wall at the top with rubber straps that were already used to mount the roof and on the side with additional rubber straps.

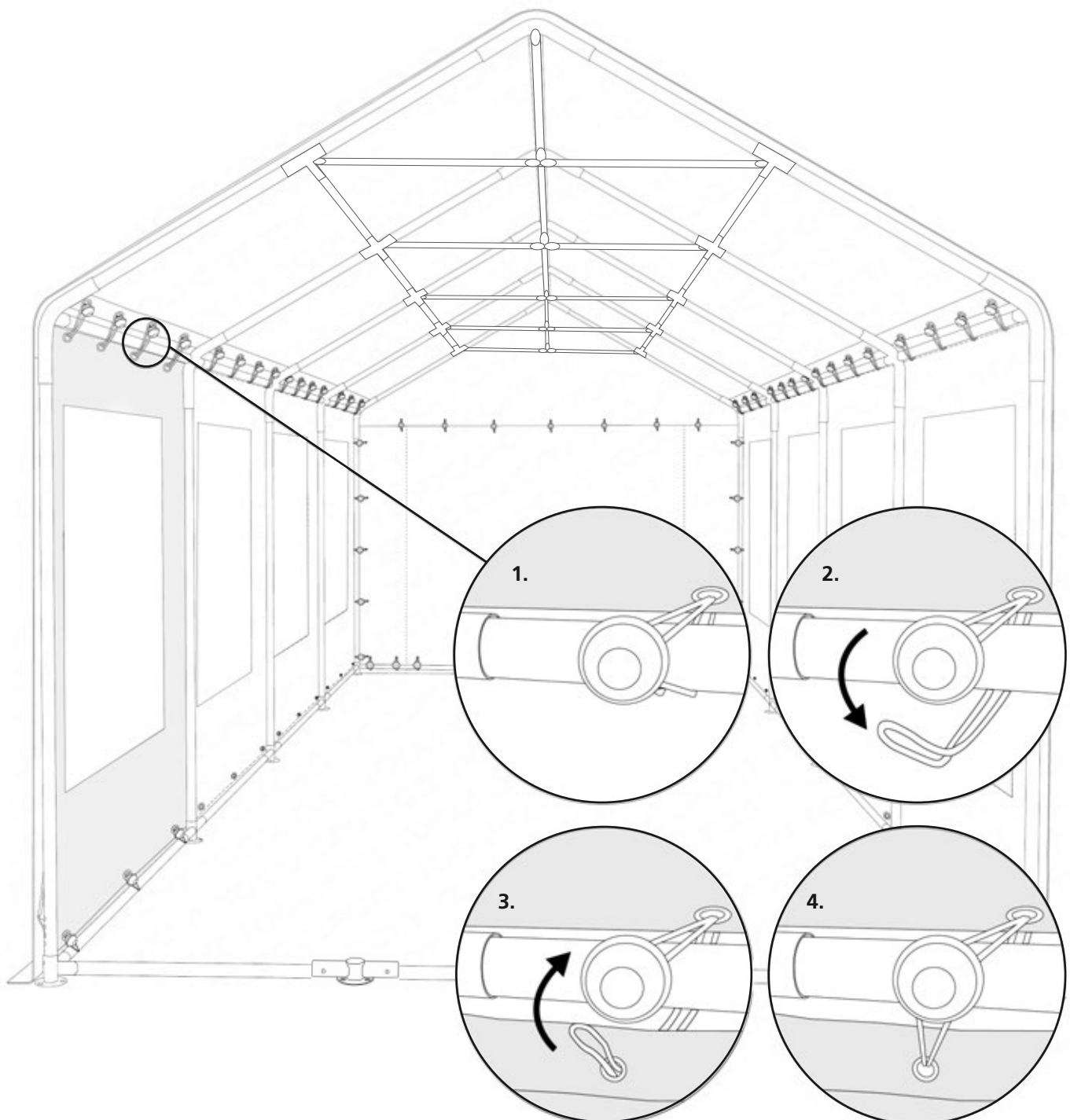

22	Spanngummi lang Long Bungee		3	6	9
----	--------------------------------	---	---	---	---



AUFBAU | ASSEMBLY

8. Sichern Sie das Partyzelt mit den Abspannseilen und Schraub-Erdhaken. Verankern Sie die Zeltplanen mit den Erdhaken im Boden.

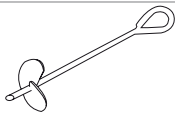
Secure the marquee with the guy ropes and ground hooks. Anchor the tarpaulin in the ground with the ground hooks.

24	Schraub-Erdhaken groß \varnothing 6 x 300 mm Peg \varnothing 6 x 300 mm	
26	Erdhaken klein \varnothing 4 x 180 mm Peg \varnothing 4 x 180 mm	
27	Abspannseil Rope	